

## TORRETTE, PORTAUTENSILI E UTENSILI DA TORNIO ...

Indice dei contenuti

■ Uni - Kit 8 .....	54
Kit 8 Cup .....	56
Kit 1-BT90 .....	58
Kit 1-P01 .....	58
Kit 3-PTR .....	59
Kit PLP .....	61
Kit 2 CST .....	53
<hr/>	
■ PORTAUTENSILI PER LIMATRICE E PIALLA .....	62
■ UTENSILI IN ACCIAIO PER TORNIO E LIMATRICE .....	63
■ PORTAUTENSILI E UTENSILI PER STOZZATRICE .....	48
■ LAME PER MORSETTO MLT .....	66
■ LAME PER PORTAUTENSILI PDT .....	68
■ UTENSILI IN HSS PER PORTAUTENSILI SI-T51 .....	70
■ UTENSILI PER LAVORAZIONE INTERNA .....	73
■ UTENSILI PER FILETTARE ESTERNO .....	52
A PROFILO COSTANTE PER P01 .....	
■ PLACCHETTE IN METALLO DURO .....	74
■ PARTI DI RICAMBIO .....	76

PORTAUTENSILE PER STOZZATRICE

PHZ

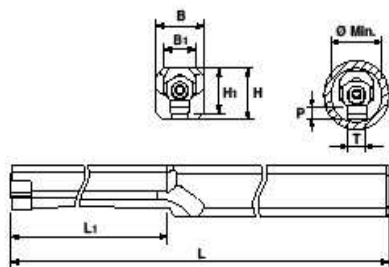

REFERIMENTO	H	H <sub>1</sub>	B	B <sub>1</sub>	L <sub>1</sub>	L	T	Ø min.	P max.		
PHZ 1104-08	11,2	9	11,3	8,5	25	160	3	9,5	1,6	DVF 2593	TX 207PLUS
PHZ 1107-08	11,2	10	11,3	7	80	200	4 5	10,9 11,1	2,5 2	DVF 2593	TX 207PLUS
PHZ 1111-08	11,2	12	11,3	-	80	200	4 5	14 14	2,5 2	DVF 2593	TX 207PLUS
PHZ 1612-10	15,5	16,2	12	-	-	220	6 8	17,8 18,2	4,2 5,2	DVF 2260	TX 207PLUS
PHZ 2014-13	20,6	21,5	14	-	-	250	10 12	24,2 24,7	6,2 7,2	5513 020-14	TX 207PLUS

HZ

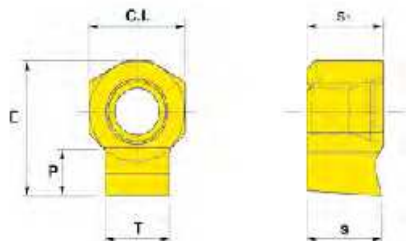

REFERIMENTO	C.L.	S	S <sub>1</sub>	L	P	T	Tolleranze su T
HZ 06 04- 30 C11	6	4,66	4,76	7,5	1,6	3	+0,020 -0,010
HZ 06 04- 40 C11	6	4,66	4,76	8,0	2,5	4	+0,020 -0,010
HZ 06 04- 60 C11	6	4,66	4,76	8,0	3,0	5	+0,020 -0,010
HZ 10 06- 80 C11	10	6,25	6,35	13,5	4,2	6	+0,020 -0,010
HZ 10 06- 90 C11	10	6,25	6,35	13,5	5,2	8	+0,020 -0,010
HZ 13 06-100 C11	13	9,40	9,525	18,5	6,2	10	+0,020 -0,010
HZ 13 06-120 C11	13	9,40	9,525	18,5	7,2	12	+0,020 -0,010
HZ 06 04- 30 H7	6	4,66	4,76	7,5	1,6	3	+0,018 -0,010
HZ 06 04- 40 H7	6	4,66	4,76	8,0	2,5	4	+0,018 -0,010
HZ 06 04- 60 H7	6	4,66	4,76	8,0	3,0	5	+0,018 -0,010
HZ 10 06- 80 H7	10	6,25	6,35	13,5	4,2	6	+0,018 -0,010
HZ 10 06- 90 H7	10	6,25	6,35	13,5	5,2	8	+0,018 -0,010
HZ 13 06-100 H7	13	9,40	9,525	18,5	6,2	10	+0,018 -0,010
HZ 13 06-120 H7	13	9,40	9,525	18,5	7,2	12	+0,018 -0,010

UTENSILI E INSERTI PER STOZZATRICE

PHZ/2

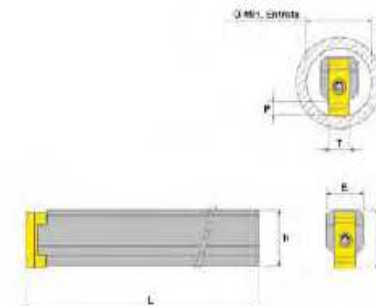
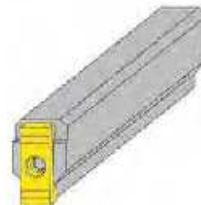

REFERIMENTO	H	H <sub>1</sub>	B	L	T	Ø min.	P max.		
PHZ /2 3825-14	38	37,5	25	300	14 16	44	8 9	5513 020-14	TX 225PLUS

HZ/2

Inserti a due taglianti

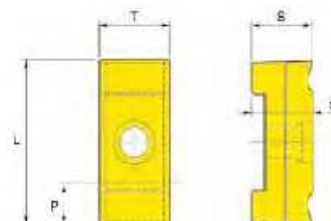

REFERIMENTO	S	S <sub>1</sub>	L	P	T	Tolleranze su T
HZ/2 14-14 C11	13,9	14	36	8	14	+0,025 -0,025
HZ/2 16-16 C11	13,9	14	36	9	16	+0,025 -0,025
HZ/2 14-14 H7	13,9	14	36	8	14	+0,018 -0,010
HZ/2 16-16 H7	13,9	14	36	9	16	+0,018 -0,010

Torrette, portautensili e utensili da tornio, stozzatrice e limatrice

Torrette, portautensili e utensili da tornio, stozzatrice e limatrice

PORTAUTENSILE PER STOZZATRICE

UTENSILI PER STOZZATRICE

PST

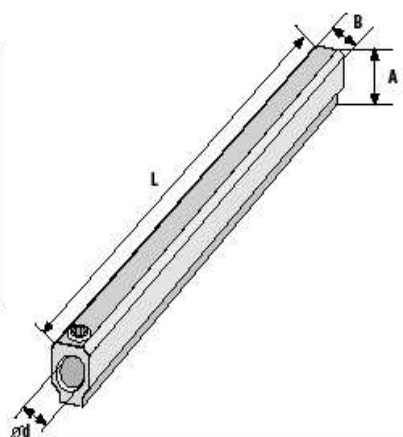
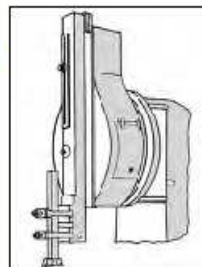

Gli utensili STZ, di corredo ai portautensili PST, sono costruiti con le misure delle chiavette unificate e le loro dimensioni sono tali da consentire il passaggio nel Ø min. per cui la chiave è prevista. Gli utensili sono disponibili in tolleranza C11, H7 e P9.

RIFERIMENTO	Ød	A	B	L		
PST 1212 - 04	4	12	12	200	UNI 5923 - M 5x5	UNI 2415 - 2,5
PST 1212 - 05	5	12	12	200	UNI 5923 - M 5x5	UNI 2415 - 2,5
PST 1612 - 06	6	14,5	12	220	UNI 5923 - M 6x6	UNI 2415 - 3
PST 1914 - 08	8	19	14	220	UNI 5923 - M 6x6	UNI 2415 - 4
PST 2616 - 10	10	26	16	250	UNI 5923 - M 10x10	UNI 2415 - 5
PST 3120 - 12	12	31	20	250	UNI 5923 - M 10x10	UNI 2415 - 5
PST 3420 - 14	14	34	20	300	UNI 5923 - M 12x12	UNI 2415 - 6
PST 4025 - 16	16	40	25	350	UNI 5923 - M 14x12	UNI 2415 - 6
PST 4630 - 18	18	46	30	376	UNI 5923 - M 16x16	UNI 2415 - 8
PST 5435 - 20	20	54	35	430	UNI 5923 - M 18x20	UNI 2415 - 10
PST 6045 - 24	24	60	45	500	UNI 5923 - M 20x20	UNI 2415 - 10
PST 6845 - 28	28	68	45	500	UNI 5923 - M 20x20	UNI 2415 - 10
PST 8650 - 32	32	85	50	600	UNI 5923 - M 24x25	UNI 2415 - 12

STZ

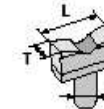
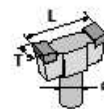

Utensili con tolleranza C 11

RIFERIMENTO	d	T	L K9	L 222s	β° mh.	C 11 T
STZ 04-04 C11	4	4	11	11	12	4 -0,070 -0,145
STZ 05-05 C11	5	5	12	12	13	5 -0,070 -0,145
STZ 06-06 C11	6	6	18	18	19	6 -0,070 -0,145
STZ 08-08 C11	8	8	21	22	24	8 -0,090 -0,170
STZ 10-10 C11	10	10	21	31	33	10 -0,090 -0,170
STZ 12-12 C11	12	12	28	38	40	12 -0,095 -0,205
STZ 14-14 C11	14	14	40	40	43	14 -0,095 -0,205
STZ 16-16 C11	16	16	45	45	48	16 -0,095 -0,205
STZ 18-18 C11	18	18	55	55	58	18 -0,095 -0,205
STZ 20-20 C11	20	20	65	65	68	20 -0,110 -0,240
STZ 20-22 C11	20	20	-	65	70	20 -0,110 -0,240
STZ 24-24 C11	24	24	70	70	74	24 -0,110 -0,240
STZ 24-25 C11	24	25	-	70	74	25 -0,110 -0,240
STZ 28-28 C11	28	28	-	80	85	28 -0,110 -0,240
STZ 32-32 C11	32	32	-	90	96	32 -0,120 -0,280

Utensili con tolleranza H 7

RIFERIMENTO	d	T	L K9	L 222s	β° mh.	H 7 T
STZ 04-04 H7	4	4	11	11	12	4 -0,012 0
STZ 05-05 H7	5	5	12	12	13	5 -0,012 0
STZ 06-06 H7	6	6	18	18	19	6 -0,012 0
STZ 08-08 H7	8	8	21	22	24	8 -0,015 0
STZ 10-10 H7	10	10	21	31	33	10 -0,015 0
STZ 12-12 H7	12	12	28	38	40	12 -0,018 0
STZ 14-14 H7	14	14	40	40	43	14 -0,018 0
STZ 16-16 H7	16	16	45	45	48	16 -0,018 0
STZ 18-18 H7	18	18	55	55	58	18 -0,018 0
STZ 20-20 H7	20	20	65	65	68	20 -0,021 0
STZ 20-22 H7	20	20	-	65	70	20 -0,021 0
STZ 24-24 H7	24	24	70	70	74	24 -0,021 0
STZ 24-25 H7	24	25	70	70	74	25 -0,021 0
STZ 28-28 H7	28	28	-	80	85	28 -0,021 0
STZ 32-32 H7	32	32	-	90	96	32 -0,025 0

Utensili con tolleranza P 9

RIFERIMENTO	d	T	L K9	L 222s	β° mh.	P 9 T
STZ 05-05 P9	5	5	12	12	13	5 -0,012 -0,042
STZ 08-08 P9	8	8	21	22	24	8 -0,015 -0,051
STZ 14-14 P9	14	14	40	40	43	14 -0,018 -0,081

A richiesta tolleranze speciali

Torrette, portautensili e utensili da tornio, stozzatrice e limatrice

Torrette, portautensili e utensili da tornio, stozzatrice e limatrice



UTENSILI PER FILETTARE ESTERNO A PROFILO COSTANTE PER P01

KIT 2 - CST

F2/60° (HSS)

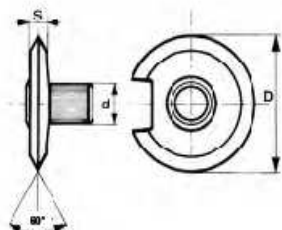
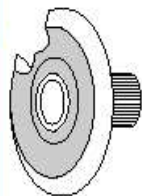

REFERIMENTO	D	d	S	P 01
F2/60° 44 T 2000 S	44	12	6,5	
F2/60° 54 T 2000 S	54	16	7	

F1/55° (HSS)

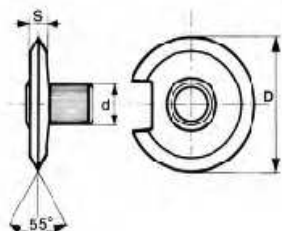
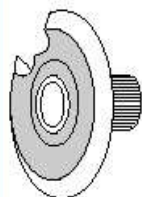



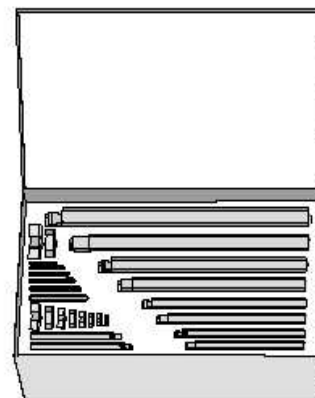

REFERIMENTO	D	d	S	P 01
F1/55° 44 T 2000 S	44	12	6,5	
F1/55° 54 T 2000 S	54	16	7	

COMPOSIZIONI PER STOZZATRICE

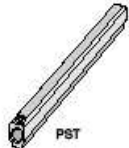

I portautensili per stozzatrice PST vengono forniti anche in astuccio corredati ognuno da un utensile in HSS ed uno con placchetta in metallo duro.

	KIT 2-CST-0412-C 11	KIT 2-CST-0412-H 7	KIT 2-CST-0420-C 11	KIT 2-CST-0420-H 7
 PST	1 PST 1212 - 04 1 PST 1212 - 05 1 PST 1512 - 06 1 PST 1914 - 08 1 PST 2616 - 10 1 PST 3120 - 12 1 1 1	1 PST 1212 - 04 1 PST 1212 - 05 1 PST 1512 - 06 1 PST 1914 - 08 1 PST 2616 - 10 1 PST 3120 - 12 1 1 1	1 PST 1212 - 04 1 PST 1212 - 05 1 PST 1512 - 06 1 PST 1914 - 08 1 PST 2616 - 10 1 PST 3120 - 12 1 PST 3420 - 14 1 PST 4025 - 16 1 PST 4630 - 18 1 PST 5435 - 20	1 PST 1212 - 04 1 PST 1212 - 05 1 PST 1512 - 06 1 PST 1914 - 08 1 PST 2616 - 10 1 PST 3120 - 12 1 PST 3420 - 14 1 PST 4025 - 16 1 PST 4630 - 18 1 PST 5435 - 20
 STZ - 2226 (HSS)	1 STZ 04 - 04 C 11 1 STZ 05 - 05 C 11 1 STZ 06 - 06 C 11 1 STZ 08 - 08 C 11 1 STZ 10 - 10 C 11 1 STZ 12 - 12 C 11 1 1 1	1 STZ 04 - 04 H 7 1 STZ 05 - 05 H 7 1 STZ 06 - 06 H 7 1 STZ 08 - 08 H 7 1 STZ 10 - 10 H 7 1 STZ 12 - 12 H 7 1 1 1	1 STZ 04 - 04 C 11 1 STZ 05 - 05 C 11 1 STZ 06 - 06 C 11 1 STZ 08 - 08 C 11 1 STZ 10 - 10 C 11 1 STZ 12 - 12 C 11 1 STZ 14 - 14 C 11 1 STZ 16 - 16 C 11 1 STZ 18 - 18 C 11 1 STZ 20 - 20 C 11	1 STZ 04 - 04 H 7 1 STZ 05 - 05 H 7 1 STZ 06 - 06 H 7 1 STZ 08 - 08 H 7 1 STZ 10 - 10 H 7 1 STZ 12 - 12 H 7 1 STZ 14 - 14 H 7 1 STZ 16 - 16 H 7 1 STZ 18 - 18 H 7 1 STZ 20 - 20 H 7
 STZ - K9	1 STZ 04 - 04 C 11 1 STZ 05 - 05 C 11 1 STZ 06 - 06 C 11 1 STZ 08 - 08 C 11 1 STZ 10 - 10 C 11 1 STZ 12 - 12 C 11 1 1 1	1 STZ 04 - 04 H 7 1 STZ 05 - 05 H 7 1 STZ 06 - 06 H 7 1 STZ 08 - 08 H 7 1 STZ 10 - 10 H 7 1 STZ 12 - 12 H 7 1 1 1	1 STZ 04 - 04 C 11 1 STZ 05 - 05 C 11 1 STZ 06 - 06 C 11 1 STZ 08 - 08 C 11 1 STZ 10 - 10 C 11 1 STZ 12 - 12 C 11 1 STZ 14 - 14 C 11 1 STZ 16 - 16 C 11 1 STZ 18 - 18 C 11 1 STZ 20 - 20 C 11	1 STZ 04 - 04 H 7 1 STZ 05 - 05 H 7 1 STZ 06 - 06 H 7 1 STZ 08 - 08 H 7 1 STZ 10 - 10 H 7 1 STZ 12 - 12 H 7 1 STZ 14 - 14 H 7 1 STZ 16 - 16 H 7 1 STZ 18 - 18 H 7 1 STZ 20 - 20 H 7
	1 BOX	1 BOX	1 BOX	1 BOX

UNI-KIT 8-P3/70

UNI-KIT 8 - CONTENUTO COMPOSIZIONI

■ COMPOSIZIONI

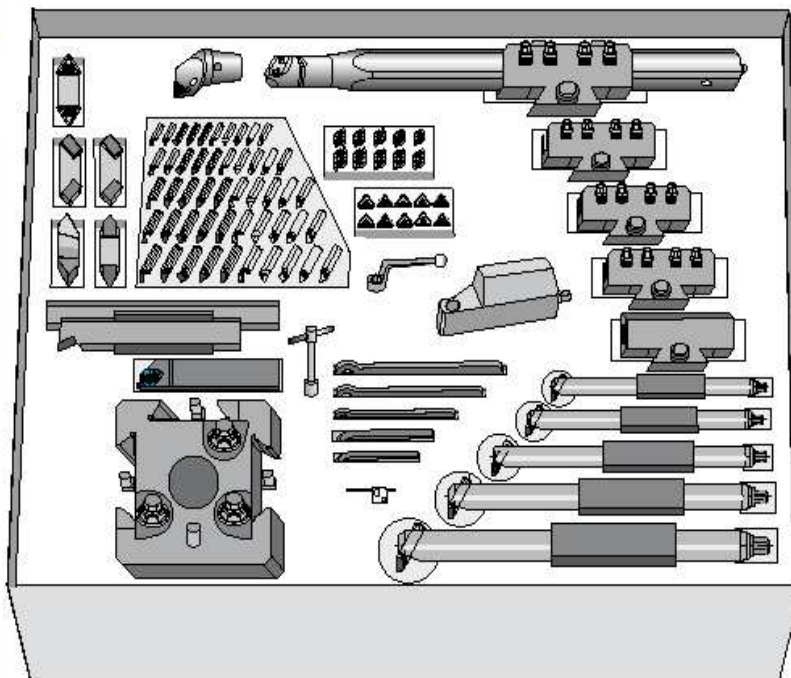

■ P3/70 - 3

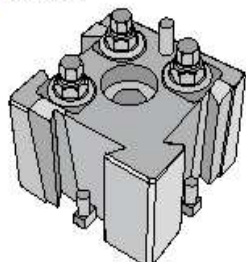

IL TIPO DI TORRETTE DETERMINA LA SCELTA DELLA COMPOSIZIONE (A-B-C-D)

	UNI-KIT 8-P3/70-96-3-A	UNI-KIT 8-P3/70-115-3-B	UNI-KIT 8-P3/70-143-3-C	UNI-KIT 8-P3/70-174-3-D UNI-KIT 8-P3/70-214-3-D
	1 P3/70-96-3-A	1 P3/70-115-3-B	1 P3/70-143-3-C	1 P3/70-174-3-D P3/70-214-3-D
	3 S 01 - A - 25	3 S 01 - B - 30	3 S 01 - C - 32	3 S 01 - D - 32
	1 PTR-1313-10	1 PTR-2118-14	1 PTR-2424-16	1 PTR-3030-18
	1 S 09 - A - 2	1 S 09 - B - 3	1 S 09 - C - 4	1 S 09 - D - 5
	—	1 S 51R - B - 40	1 S 51 - C - 40	1 S 51 - D - 40
	—	1 P51-4036-32+T51	1 P51-4036-32+T51	1 P51-4036-32+T51
	—	1 T535-32-TC 16	1 T535-32-TC 16	1 T535-32-TC16
	1 SI - 10 - 04 1 SI - 12 - 05 1 SI - 16 - 07 1 SI - 20 - 08 —	1 SI - 10 - 04 1 SI - 12 - 05 1 SI - 16 - 07 1 SI - 20 - 08 1 SI - 25 - 10	1 SI - 10 - 04 1 SI - 12 - 05 1 SI - 16 - 07 1 SI - 20 - 08 1 SI - 25 - 10	— — 1 SI - 16 - 07 1 SI - 20 - 08 1 SI - 25 - 10
	1 P90-2020-10 1 P90-2020-12 1 P90-2020-16 1 P90-2525-20 —	1 P90-3025-10 1 P90-3025-12 1 P90-3025-16 1 P90-3030-20 1 P90-3030-25	1 P90-3025-10 1 P90-3025-12 1 P90-3025-16 1 P90-3030-20 1 P90-3030-25	— — 1 P90-3025-16 1 P90-3030-20 1 P90-3030-25
	1 MLT-2518-LM 17	1 MLT-3020-LM 20	1 MLT-3422-LU 23	1 MLT-3422-LU 23
	1 M26S-RL10-TC11	1 M26S-RL14-TC16	1 M26S-RL16-TC16	1 M26S-RL18-TC16
	1 P21.SFR-2020K-10	1 P21.SFR-2020K-10	1 P21.SFR-2525M-10	1 P21.SFR - 2525M-10
	1 S25T-SEUCR 08	—	—	—
	SET-X21-10-ER 3 X21.B3 100M1-60-ER 2 X21.B3 100M1-55-ER 3 X21.B3 100M1-48-ER 2 X21.B3 100M1-53-ER	SET-X21-10-ER 3 X21.B3 100M1-60-ER 2 X21.B3 100M1-55-ER 3 X21.B3 100M1-48-ER 2 X21.B3 100M1-53-ER	SET-X21-10-ER 3 X21.B3 100M1-60-ER 2 X21.B3 100M1-55-ER 3 X21.B3 100M1-48-ER 2 X21.B3 100M1-53-ER	SET-X21-10-ER 3 X21.B3 100M1-60-ER 2 X21.B3 100M1-55-ER 3 X21.B3 100M1-48-ER 2 X21.B3 100M1-53-ER
	SET-EC... SET-TC... 2 SET-EC-09-L 2 ECMT 080302-L 2 ECMT 080304-2R 2 ECMT 080304-2R 2 ECMT 080308-4M 2 ECGT 080304-2I	SET-TC-16 2 TCMT 16T304-33 3 TCMT 16T308-33 3 TCMT 16T308-2R 2 TCGT 16T306-1L	SET-TC-16 2 TCMT 16T304-33 3 TCMT 16T308-33 3 TCMT 16T308-2R 2 TCGT 16T306-1L	SET-TC-16 2 TCMT 16T304-33 3 TCMT 16T308-33 3 TCMT 16T308-2R 2 TCGT 16T306-1L
	10 TCMT 110204-2M	—	—	—
	SET 40/17/2 1 LUN 1740-200N 1 LMS 1750-150L	SET 40/20/2 1 LUN 2040-200N 1 LMS 2050-170L	SET 40/23/2 1 LUN 2340-200N 1 LUS 2355-150L	SET 40/23/2 1 LUN 2340-200N 1 LUS 2355-150L
	1 AB-10	1 AB-14	1 AB-16	1 AB-18
	1 FB-10 1 FC-10 1 DD-10	1 FB-14 1 FC-14 1 DD-14	1 FB-16 1 FC-16 1 DD-16	1 FB-18 1 FC-18 1 DD-18
	1 SET 10/4 1 SET 10/5 1 SET 10/7 1 SET 10/8 —	1 SET 10/4 1 SET 10/5 1 SET 10/7 1 SET 10/8 1 SET 10/10 1 SET 10/12	1 SET 10/4 1 SET 10/5 1 SET 10/7 1 SET 10/8 1 SET 10/10 1 SET 10/12	— — 1 SET 10/7 1 SET 10/8 1 SET 10/10 1 SET 10/12
	—	—	—	—
	1 SET CHIAVI DI SERVIZIO 1 Sagoma UNI-INT 8 A BOX 07 (625x218x150)	1 SET CHIAVI DI SERVIZIO 1 Sagoma UNI-INT 8 B BOX 07 (625x218x150)	1 SET CHIAVI DI SERVIZIO 1 Sagoma UNI-INT 8 C BOX 08 (645x230x195)	1 SET CHIAVI DI SERVIZIO 1 Sagoma UNI-INT 8 D BOX 08 (645x230x195)

Torrette, portautensili e utensili da tornio, stozzatrice e limatrice

Torrette, portautensili e utensili da tornio, stozzatrice e limatrice

KIT 8-CUP

KIT 8-CUP - CONTENUTO COMPOSIZIONI

■ COMPOSIZIONI

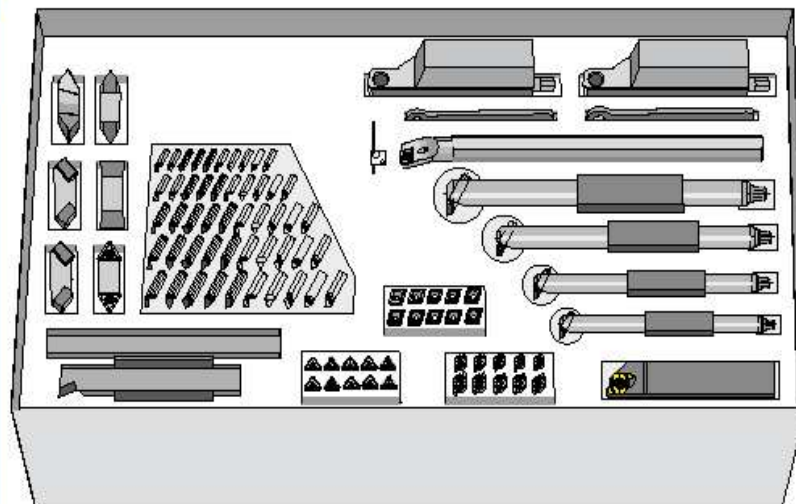

PARTICOLARMENTE INDICATA PER TORRETTE RAPIDE REGISTRABILI IN ALTEZZA

	H max = 20	H max = 25	H max = 30
	KIT8-CUP-A-20	KIT8-CUP-B-25	KIT8-CUP-C-30

H max = INGOMBRO DEL PORTAUTENSILE PIÙ GRANDE NELLA COMPOSIZIONE

	KIT8-CUP-A-20	KIT8-CUP-B-25	KIT8-CUP-C-30
	2 PTR-1815-12	2 PTR-2118-14	2 PTR-2424-16
	1 FB-12	1 FB-14	1 FB-16
	1 FC-12	1 FC-14	1 FC-16
	1 DD-12	1 DD-14	1 DD-16
	1 CP-12	1 CP-14	1 CP-16
	1 AB-12	1 AB-14	1 AB-16
	1 M26S-RL12-TC11	1 M26S-RL14-TC16	1 M26S-RL16-TC16
	1 SET-EC-08-L 1 SET-TC-11	1 SET-TC-16	1 SET-TC-16
	1 P21.SFR-2020K-10	1 P21.SFR-2020K-10	1 P21.SFR-2525M-10
	1 SET-X21-10-ER	1 SET-X21-10-ER	1 SET-X21-10-ER
	1 MLT-2014-LM 13	1 MLT-2518-LM 17	1 MLT-3020-LM 20
	1 SET 40/13/2 (LMN 1330-200 N) 1 LMS... (LMS 1340-140 L)	1 SET 40/17/2 (LMN 1740-200 N) 1 LMS... (LMS 1750-150 L)	1 SET 40/20/2 (LMN 2040-200 N) 1 LMS... (LMS 2050-170 L)
	1 S20S-SEUCR 08 1 STPCR	1 S25T-STFCR-16-M	1 S32U-STFCR 16
	1 SH-10-04 1 SH-12-05 1 SH-16-07 —	1 SH-10-04 1 SH-12-05 1 SH-16-07 1 SH-20-08 —	1 SH-10-04 1 SH-12-05 1 SH-16-07 1 SH-20-08 1 SH-25-10
	1 SET 10/4 1 SET 10/5 1 SET 10/7 —	1 SET 10/4 1 SET 10/5 1 SET 10/7 1 SET 10/8 —	1 SET 10/4 1 SET 10/5 1 SET 10/7 1 SET 10/8 1 SET 10/10
	1 P90-2020-10 1 P90-2020-12 1 P90-2020-16 —	1 P90-2020-10 1 P90-2020-12 1 P90-2020-16 1 P90-2525-20 —	1 P90-3025-10 1 P90-3025-12 1 P90-3025-16 1 P90-3030-20 1 P90-3030-25
	1 BOX	1 BOX	1 BOX

Torrette, portautensili e utensili da tornio, stozzatrice e limatrice

Torrette, portautensili e utensili da tornio, stozzatrice e limatrice



KIT 1-BT90 e KIT 1-P01

KIT 3-PTR

■ KIT 1-BT90 . CONTENUTO E COMPOSIZIONI

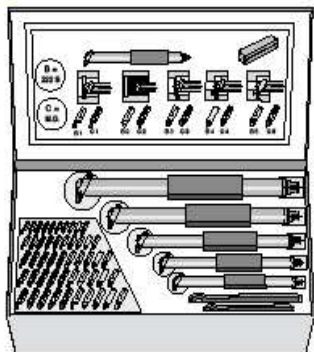

	KIT 1-BT90-2510-30	KIT 1-BT90-3212-40
	1 SF-10-04 1 SF-12-05 1 SF-16-07 1 SF-20-08 1 SF-25-10	1 SF-10-04 1 SF-12-05 1 SF-16-07 1 SF-20-08 1 SF-25-10 1 SF-22-12
	1 P90-2020-10 1 P90-2020-12 1 P90-2020-16 1 P90-2525-20 1 P90-3030-25	1 P90-2020-10 1 P90-2020-12 1 P90-2020-16 1 P90-2525-20 1 P90-3030-25 1 P90-3037-32
	1 SET 10/4 1 SET 10/5 1 SET 10/7 1 SET 10/8 1 SET 10/10	1 SET 10/4 1 SET 10/5 1 SET 10/7 1 SET 10/8 1 SET 10/10 1 SET 10/12
	1 1502 CHIAVE 1 1504 CHIAVE	1 1502 CHIAVE 1 1504 CHIAVE
	1 BOX	1 BOX

	H max = 30mm	H max = 40mm
	KIT 1 BT90-2515-30	KIT 1 BT90-3212-40

H max = INGOMBRO DEL PORTAUTENSILE PIÙ GRANDE NELLA COMPOSIZIONE

■ KIT 1-P01 . CONTENUTO E COMPOSIZIONI

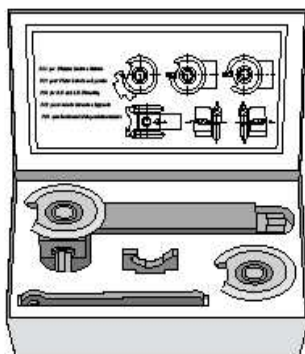

	KIT 1-P01-2020-44	KIT 1-P01-2525-54
	1 P01-2020-44	1 P01-2525-54
	1 2554 SQUADRETTA	1 2574 SQUADRETTA
	1 F1/55°-44 1 F2/60°-44	1 F1/55°-54 1 F2/60°-54
	1 1502 CHIAVE	1 1504 CHIAVE
	1 BOX	1 BOX

	H max = 16mm	H max = 20mm	H max = 25mm
	KIT 1 P01 1620-44	KIT 1 P01 2020-44	KIT 1 P01 2525-44

H max = INGOMBRO DEL PORTAUTENSILE PIÙ GRANDE NELLA COMPOSIZIONE

■ KIT 3-PTR . CONTENUTO E COMPOSIZIONI

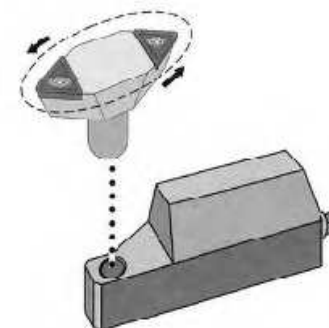
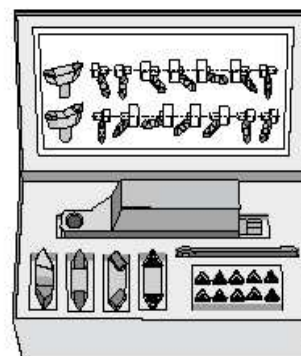

	KIT 3-PTR-1815-12	KIT 3-PTR-2118-14	KIT 3-PTR-2424-16
	1 PTR-1815-12	1 PTR-2118-14	1 PTR-2424-16
	1 AC-12	1 AC-14	1 AC-16
	1 FB-12	1 FB-14	1 FB-16
	1 DD-12	1 DD-14	1 DD-16
	1 M26S-RL12-TC11	1 M26S-RL14-TC16	1 M26S-RL16-TC16
	1 SET-TC-11	1 SET-TC-16	1 SET-TC-16
	1 1504 CHIAVE	1 1504 CHIAVE	1 1506 CHIAVE
	1 BOX	1 BOX	1 BOX

	H max = 18mm	H max = 21mm	H max = 24mm
	KIT 3-PTR-1815-12	KIT 3-PTR-2118-14	KIT 3-PTR-2424-16

H max = INGOMBRO DEL PORTAUTENSILE PIÙ GRANDE NELLA COMPOSIZIONE

PER FILETTARE

COMPOSIZIONI PER LIMATRICE E PIALLA

■ P01

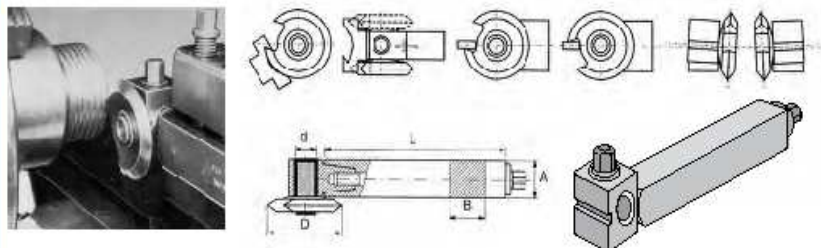

RIFERIMENTO	B mm	A mm	L mm	d mm	S mm				
P01 - 1620 - 44	16	20	110	12	44	F2/60°T2000S F1/55°T2000S	1139	1502	1084
P01 - 2020 - 44	20	20	110	12	44		1139	1502	1084
P01 - 2525 - 54	25	25	135	16	54		1162	1504	1105

■ KIT -PLP

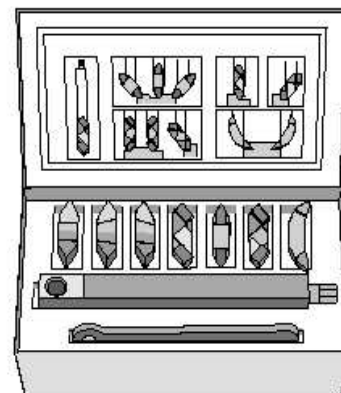

I portautensili PLP vengono forniti anche in una valigetta contenente il portautensile PLP con una serie di sette utensili orientabili a doppio profilo.

	KIT - PLP - 2820 - 14		KIT - PLP - 3525 - 16	
	1	PLP 2820 - 14	1	PLP 3525 - 16
	1	FB - 14 K9	1	FB - 16 K9
	1	FCS - 14 M3	1	DO - 16 P6
	1	FCS - 14 M2	1	FCS - 16 M3
	1	DA - 14 K9	1	DA - 16 K9
	1	AB - 14	1	AB - 16
	1	ACS - 14	1	ACS - 16
	1	AD - 14	1	AC - 16
	1	1504 CHIAVE	1	1506 CHIAVE
	1	BOX	1	BOX



PORTAUTENSILE PER LIMATRICE E PIALLA

UTENSILI IN ACCIAIO PER TORNIO E LIMATRICE

■ PLP

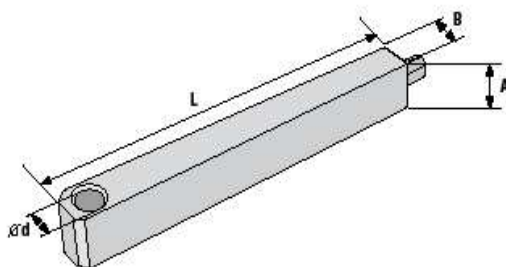

RIFERIMENTO	Ø d	A	B	L			
PLP 2820 - 14	14	28	20	180	1504	1121	1711
PLP 3825 - 16	16	38	25	250	1506	1161	1726

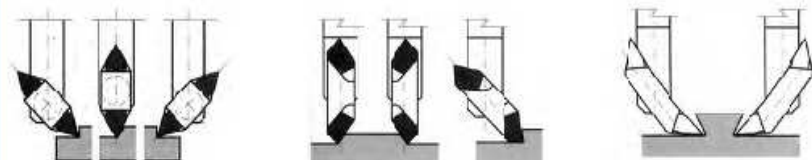

■ AB (HSS)

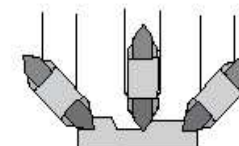
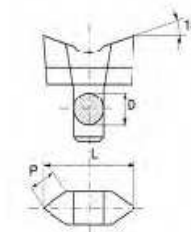
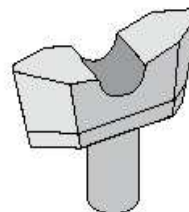

RIFERIMENTO	D	P	L
AB - 10 222 S	10	10	36
AB - 12 222 S	12	12	41
AB - 14 222 S	14	14	45
AB - 16 222 S	16	16	56
AB - 18 222 S	18	18	66
AB - 22 222 S	22	24	78

■ AC (HSS)

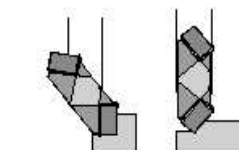
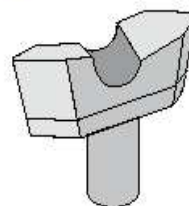

RIFERIMENTO	D	P	L
AC - 12 222 S	12	12	41
AC - 14 222 S	14	14	45
AC - 16 222 S	16	16	56
AC - 18 222 S	18	18	66
AC - 22 222 S	22	24	78

UTENSILI IN ACCIAIO PER TORNIO E LIMATRICE

UTENSILI PER TORNIO E LIMATRICE

■ ACS (HSS)

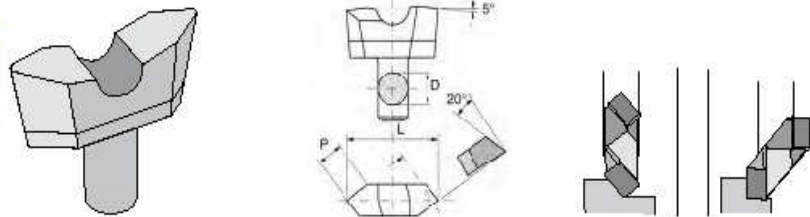

REFERIMENTO	D	P	L
ACS - 12 222 S	12	12	41
ACS - 16 222 S	16	16	56
ACS - 18 222 S	18	18	66

■ AD (HSS)

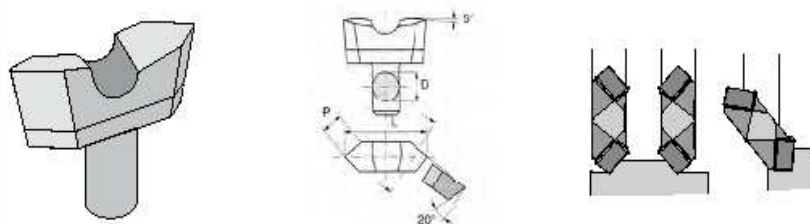

REFERIMENTO	D	P	L
AD - 14 222 S	14	14	45
AD - 16 222 S	16	16	56

■ DA (HSS)

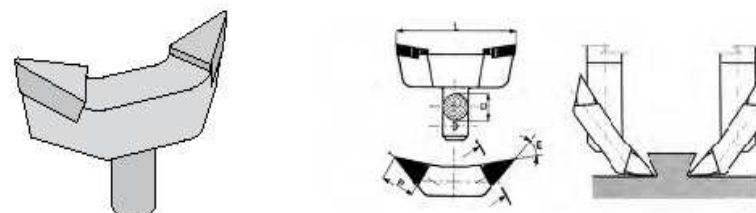

REFERIMENTO	D	P	L	E
DA - 16 222 S	16	23	80	45°
DA - 18 222 S	18	27	90	45°
DA - 22 222 S	22	29	100	45°

■ DA (MD)

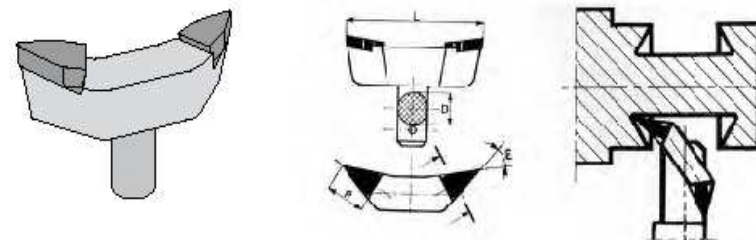

REFERIMENTO	D	L	P PLACCHETTA	E	PTR
DA - 12	12	60	DA 12	40°	
DA - 14	14	70	DA 14	40°	
DA - 16	16	80	DA 16	40°	
DA - 18	18	90	DA 18	40°	

LAME PER MORSETTO MLT

LAME PER MORSETTO MLT

■ LMS..L - LUS..L

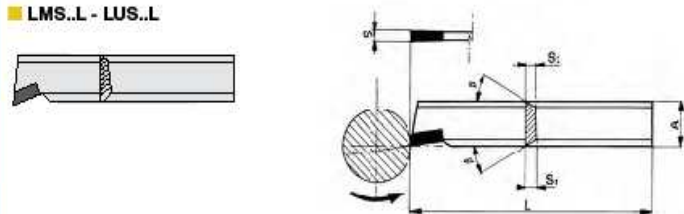

RIFERIMENTO	A	s <sub>1</sub>	s <sub>2</sub>	L	s	β	MLT
LMS 1030-120L	10	2,5	2	120	3	15°	
LMS 1340-140L	13	3,2	2,7	140	4	15°	
LMS 1760-160L	17	4,2	3,5	160	5	15°	
LMS 2060-170L	20	4,2	3,4	170	5	15°	
LUS 2366-160L	23,5	4,5	3,5	160	5,5	30°	

■ LMS..R

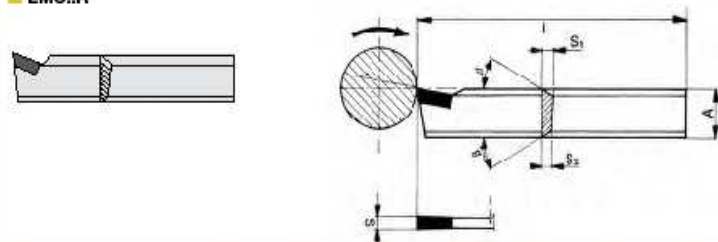

RIFERIMENTO	A	s <sub>1</sub>	s <sub>2</sub>	L	s	β	MLT
LMS 2060-170R	20	4,2	3,4	170	5	15°	

■ LMN..N (HSS)



RIFERIMENTO	A	s <sub>1</sub>	s <sub>2</sub>	L	β	MLT
LMN 1020-200N	10	2	1	200	15°	
LMN 1025-200N	10	2,5	1,5	200	15°	
LMN 1030-200N	10	3	2	200	15°	
LMN 1040-200N	10	4	3	200	15°	
LMN 1320-200N	13	2	1	200	15°	
LMN 1325-200N	13	2,5	1,5	200	15°	
LMN 1330-200N	13	3	2	200	15°	
LMN 1340-200N	13	4	3	200	15°	
LMN 1350-200N	13	5	4	200	15°	
LMN 1720-200N	17	2	1	200	15°	
LMN 1725-200N	17	2,5	1,5	200	15°	
LMN 1730-200N	17	3	2	200	15°	
LMN 1735-200N	17	3,5	3	200	15°	
LMN 1740-200N	17	4	4	200	15°	
LMN 1750-200N	17	5	5	200	15°	
LMN 2020-200N	20	2	1	200	15°	
LMN 2025-200N	20	2,5	1,5	200	15°	
LMN 2030-200N	20	3	2	200	15°	
LMN 2035-200N	20	3,5	2,5	200	15°	
LMN 2040-200N	20	4	4	200	15°	
LMN 2050-200N	20	5	5	200	15°	



LAME PER PORTAUTENSILI PDT

LAME PER PORTAUTENSILI MLT E PDT

■ LUT.L

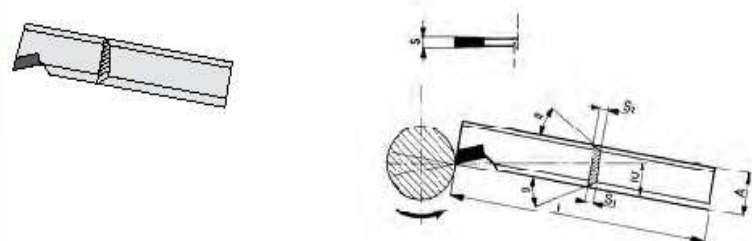

REFERIMENTO	A	S <sub>1</sub>	S <sub>2</sub>	L	S	β	PDT
LUT 2060-120L	20	4,2	3,4	120	5	30°	
LUT 2365-150L	23,5	4,5	3,5	150	5,5	30°	

■ LC.. (HSS)

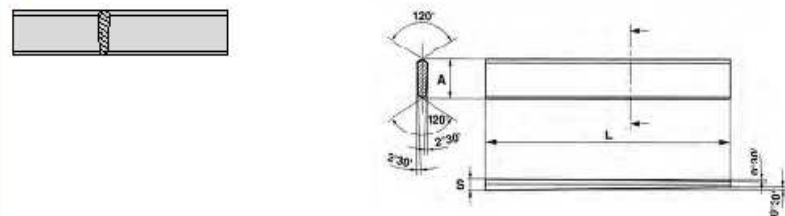

REFERIMENTO	A	L	S	P04
LC 15/4	15	120	4	
LC 20/5	20	140	5	

■ LUT..L (HSS)

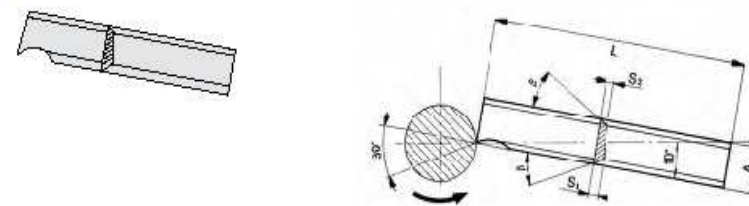

REFERIMENTO	A	S <sub>1</sub>	S <sub>2</sub>	L	β	PDT
LUT 2030-200L	20	3	2	200	30°	
LUT 2040-200L	20	4	3	200	30°	
LUT 2330-200L	23,5	3	2	200	30°	
LUT 2340-200L	23,5	4	3	200	30°	

■ LUN..N (HSS)



REFERIMENTO	A	S <sub>1</sub>	S <sub>2</sub>	L	β	PDT
LUN 1830-200N	18	3	2	200	30°	
LUN 2030-200N	20	3	2	200	30°	
LUN 2040-200N	20	4	3	200	30°	
LUN 2060-200N	20	5	4	200	30°	
LUN 3040-200N	30	4	3	200	30°	
LUN 3060-200N	30	5	4	200	30°	

REFERIMENTO	A	S <sub>1</sub>	S <sub>2</sub>	L	β	MLT
LUN 2330-200N	23,5	3	2	200	30°	
LUN 2340-200N	23,5	4	3	200	30°	
LUN 2360-200N	23,5	5	4	200	30°	

Torrette, portautensili e utensili da tornio, stozzatrice e limatrice

Torrette, portautensili e utensili da tornio, stozzatrice e limatrice

UTENSILI IN HSS PER PORTAUTENSILI SI - T51

UTENSILI IN HSS PER PORTAUTENSILI SI - T51

B1

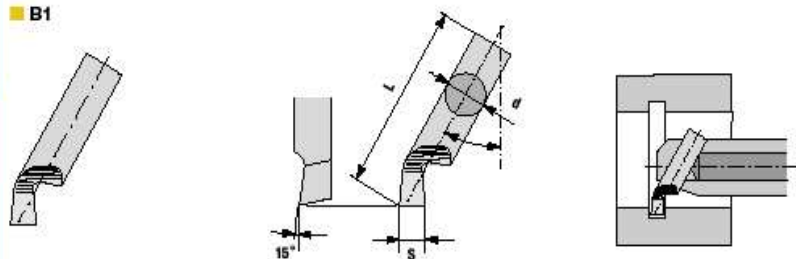

REFERIMENTO	d	L	s
B1 - 04 222 S	4	18	2,5
B1 - 05 222 S	5	22	3
B1 - 07 222 S	7	30	4,5
B1 - 08 222 S	8	40	5
B1 - 10 222 S	10	50	6,5
B1 - 12 222 S	12	60	8
B1 - 16 222 S	16	70	10

B2/60°

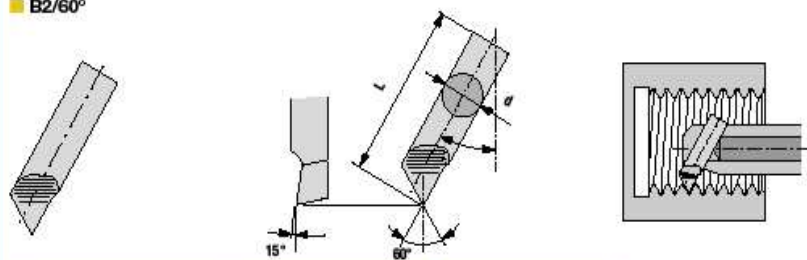

REFERIMENTO	d	L
B2/60° - 04 222 S	4	18
B2/60° - 05 222 S	5	22
B2/60° - 07 222 S	7	30
B2/60° - 08 222 S	8	40
B2/60° - 10 222 S	10	50
B2/60° - 12 222 S	12	60
B2/60° - 16 222 S	16	70

B2/55°

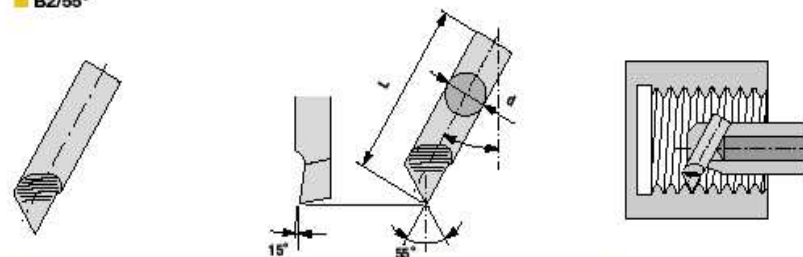

REFERIMENTO	d	L
B2/55° - 04 222 S	4	18
B2/55° - 05 222 S	5	22
B2/55° - 07 222 S	7	30
B2/55° - 08 222 S	8	40
B2/55° - 10 222 S	10	50
B2/55° - 12 222 S	12	60

B3

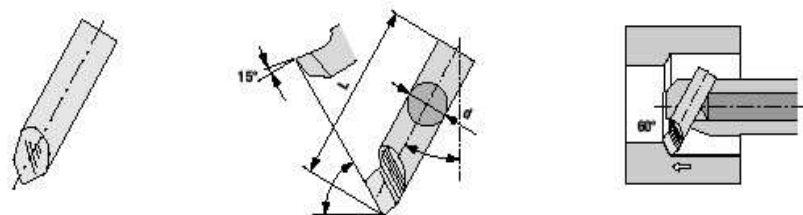

REFERIMENTO	d	L
B3 - 04 222 S	4	18
B3 - 05 222 S	5	22
B3 - 07 222 S	7	30
B3 - 08 222 S	8	40
B3 - 10 222 S	10	50
B3 - 12 222 S	12	60

UTENSILI IN HSS PER PORTAUTENSILI SI - T51

UTENSILI PER LAVORAZIONE INTERNA

■ B4

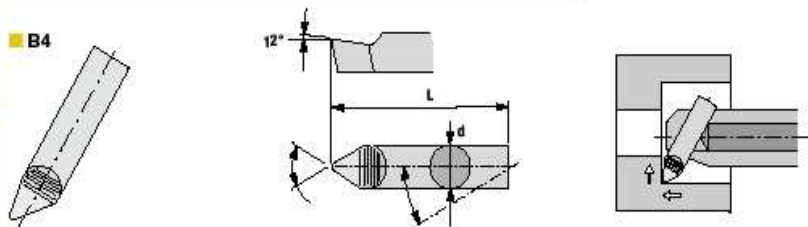

RIFERIMENTO	d	L
B4 - 04 222 \$	4	18
B4 - 05 222 \$	5	22
B4 - 07 222 \$	7	30
B4 - 08 222 \$	8	40
B4 - 10 222 \$	10	50
B4 - 12 222 \$	12	60

■ B5

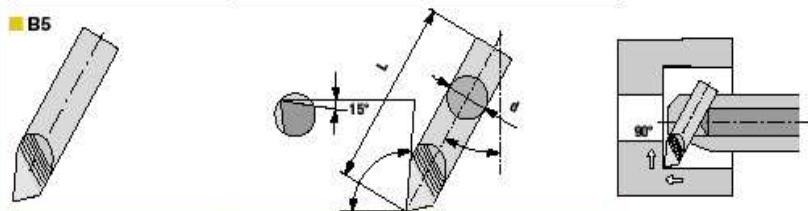

RIFERIMENTO	d	L
B5 - 04 222 \$	4	18
B5 - 05 222 \$	5	22
B5 - 07 222 \$	7	30
B5 - 08 222 \$	8	40
B5 - 10 222 \$	10	50
B5 - 12 222 \$	12	60
B5 - 16 222 \$	16	70

■ BN

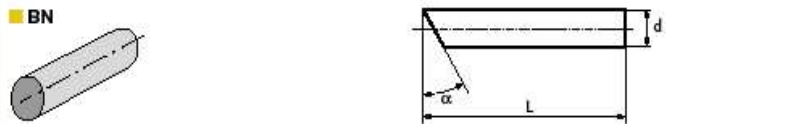

RIFERIMENTO	d	L	α
BN - 08 222 \$	8	40	30°

■ ES 4974

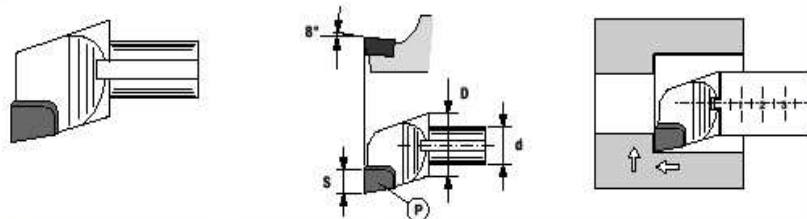

RIFERIMENTO	D	d	P PLACCHETTA	S
ES 4974 - 18	18	11	ABC 10	6
ES 4974 - 20	20	14	ABC 12	8
ES 4974 - 25	25	18	ABC 16	10

■ DAI

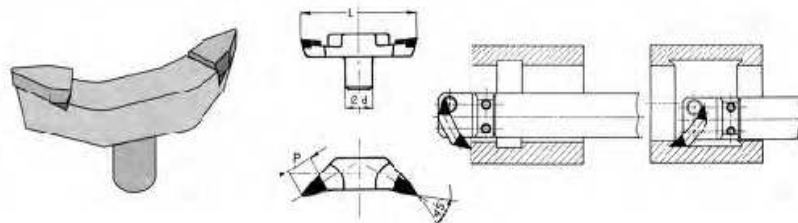







RIFERIMENTO	D	L	P PLACCHETTA
DAI - 14	14	11	E12-IMP
DAI - 16	16	14	DA 12
DAI - 18	18	18	DA 16

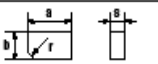
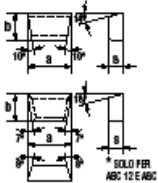
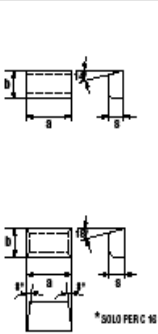

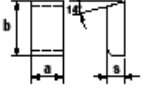
PLACCHETTE IN METALLO DURO

PLACCHETTE IN METALLO DURO

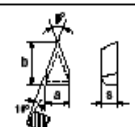
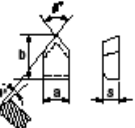
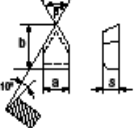
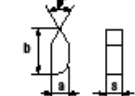
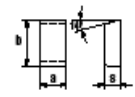
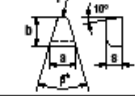
RIFERIMENTO	DIMENSIONI PLACCHETTE					
	a	b	s	r	β°	
	Piacchetta AB 6	6	4	2,5	2,5	-
	Piacchetta AB 8	8	5	3	3	-
	Piacchetta ABC 10	10	6	4	-	-
	Piacchetta ABC 12*	12	8	5	-	-
	Piacchetta ABC 16*	16	10	6	-	-
	Piacchetta ABC 20	21	12	7	-	-
	Piacchetta ABC 25	26	14	8	-	-
	Piacchetta C5 M	5,5	3	2	-	-
	Piacchetta C6	6	4	2,5	-	-
	Piacchetta C6 M	6,5	4	2,5	-	-
	Piacchetta C7	7	5	2,5	-	-
	Piacchetta C8	8	5	3	-	-
	Piacchetta C8 M	8,5	5	3	-	-
	Piacchetta C10	10	6	4	-	-
	Piacchetta C10 M	10,5	6	4	-	-
	Piacchetta C12	12	8	5	-	-
	Piacchetta C12 M	12,7	8	5	-	-
	Piacchetta C14 M	14,7	10	5	-	-
	Piacchetta C16*	16	10	6	-	-
	Piacchetta C16 M	16,8	10	6	-	-
	Piacchetta C18 M	18,8	11	6	-	-
	Piacchetta C20	20	12	7	-	-
	Piacchetta C20 M	21	12	7	-	-
Piacchetta C25	25	14	8	-	-	
Piacchetta C25 M	26	14	8	-	-	
	Piacchetta CP 12	12	8	5	-	30°
	Piacchetta CP 16	16	10	6	-	30°
	Piacchetta D3	3,5	8	3	-	30°
	Piacchetta D4	4,5	10	4	-	30°
	Piacchetta D6	5,5	12	5	-	-
	Piacchetta D6	6,5	14	6	-	-
	Piacchetta D8	8,5	16	8	-	-
	Piacchetta TFR 12	12	8	4	-	45°
	Piacchetta TFL 12	12	8	4	-	45°

RIFERIMENTO	DIMENSIONI PLACCHETTE					
	a	b	s	r	β°	
	Piacchetta DA 12	8	15	4	-	45°
	Piacchetta DA 16	10	19	5	-	45°
	Piacc. E 8-IMP	4	8	3	-	80°
	Piacc. E 10-IMP	5	10	3	-	80°
	Piacc. E 12-IMP	6	12	3	-	80°
	Piacchetta E 8	8	16	4	-	80°
	Piacchetta E 10	10	18	5	-	80°
Piacchetta E 12	12	20	6	-	80°	
	Piacchetta FB 10	7	10	3,5	-	65°
	Piacchetta FB 12	8	13	4	-	65°
	Piacchetta FB 14	9	14	5	-	65°
	Piacchetta FB 16	11	16	6	-	65°
	Piacchetta FB 18	14	20	7	-	65°
	Piacchetta FB 22	16	23	8	-	65°
	Piacchetta FIL 3,5	3,5	12	3,5	-	80°
	Piacchetta FIL 4	4	14	4	-	80°
	Piacchetta FIL 5	5	16	5	-	80°
	Piacchetta FIL 6	6	20	6	-	80°
	Piacchetta GOR 3	3,5	6	2,5	-	-
	Piacchetta GOR 4	4,5	8	3	-	-
	Piacchetta GOR 5	5,5	10	3,5	-	-
	Piacchetta GOR 6	6,5	12	4	-	-
	Piacchetta GOR 8	8,5	14	5	-	-
	Piacchetta PR 10	10	14	4	1,5	30°
	Piacchetta TR 20-36°	20	25	6	5,8	36°
	Piacchetta LR3-20	20	3	2	3	-
	Piacchetta LR4-20	20	4	2,5	4	-

Torrette, portautensili e utensili da tornio, stozzatrice e limatrice

Torrette, portautensili e utensili da tornio, stozzatrice e limatrice